

CHEVROLET



2023  
**TRaverse**

## Your peace of mind is top of mind.

The stylish exterior may be what catches your eye, but it's the dedication to safety and real-world functionality that will hold your attention.

Every Traverse includes Chevy Safety Assist<sup>1</sup>, a comprehensive suite of six driver assistance features that includes Automatic Emergency Braking, Front Pedestrian Braking, Lane Keep Assist with Lane Departure Warning, Forward Collision Alert, IntelliBeam<sup>®</sup> and Following Distance Indicator. A choice of seating for seven or eight<sup>2</sup> and best-in-class 98.2 cubic feet of cargo space<sup>3,4</sup> provide the flexibility to handle just about any situation. When you're on the go, you're surrounded by exceptional connectivity and convenience features.

Prepare to take on the day in the 2023 Traverse — a midsize SUV for a full-size life.



Traverse Premier in Iridescent Pearl Tricoat (extra-cost color).

<sup>1</sup> Safety or driver assistance features are no substitute for the driver's responsibility to operate the vehicle in a safe manner. Read the vehicle Owner's Manual for important feature limitations and information. <sup>2</sup> Seating for eight is standard on LS; available on LT, RS, Premier and High Country seat seven. <sup>3</sup> With second- and third-row seats folded flat. Cargo and load capacity limited by weight and distribution. <sup>4</sup> Based on latest available competitive information.

## At a glance.

- Chevy Safety Assist<sup>1</sup> standard on all models, includes
  - Automatic Emergency Braking
  - Front Pedestrian Braking
  - Lane Keep Assist with Lane Departure Warning
  - Forward Collision Alert
  - IntelliBeam
  - Following Distance Indicator
- Adaptive Cruise Control<sup>1</sup> standard on RS, Premier and High Country; available on LT Leather
- Safety Alert Seat<sup>1</sup> standard on Premier and High Country
- Versatile SUV with seating for seven or eight<sup>2</sup>
- Smart Slide<sup>®</sup> second-row seat
- Best-in-class 98.2 cubic feet of maximum cargo space<sup>3,4</sup> with second- and third-row seats folded flat
- Wireless Apple CarPlay<sup>®5</sup> and wireless Android Auto<sup>™6</sup> compatibility
- 8-inch diagonal Driver Information Center standard on Premier and High Country
- Automatic Stop/Start with override
- Standard LED headlamps, taillamps and daytime running lamps
- Available SkyScape<sup>®</sup> dual-panel sunroof and fixed rear skylight with power rear sunshade
- 5,000 lbs. of maximum towing capability<sup>7</sup>
- Hands-free programmable power liftgate standard on Premier and High Country
- Hidden underfloor cargo area storage
- Available all-wheel drive



Traverse High Country interior in Jet Black with Clove accents.



Traverse Premier in Summit White with available Redline Edition.

<sup>1</sup> Safety or driver assistance features are no substitute for the driver's responsibility to operate the vehicle in a safe manner. Read the vehicle Owner's Manual for important feature limitations and information. <sup>2</sup> Seating for eight is standard on LS; available on LT, RS, Premier and High Country seat seven. <sup>3</sup> Cargo and load capacity limited by weight and distribution. <sup>4</sup> Based on latest available competitive information. <sup>5</sup> Vehicle user interface is a product of Apple and its terms and privacy statements apply. Requires compatible iPhone and data plan rates apply. <sup>6</sup> Vehicle user interface is a product of Google and its terms and privacy statements apply. To use Android Auto on your car display, you'll need an Android phone running Android 6 or higher, an active data plan, and the Android Auto app. <sup>7</sup> With available trailering equipment. Maximum trailering ratings are intended for comparison purposes only. Before you buy a vehicle or use it for trailering, carefully review the Trailering section of the Owner's Manual. The trailering capacity of your specific vehicle may vary. The weight of passengers, cargo and options or accessories may reduce the amount you can trailer.

Apple CarPlay, iPhone, Siri and Apple Music are trademarks of Apple Inc., registered in the U.S. and other countries. Google, Android and Android Auto are trademarks of Google LLC.



## Six models to choose from.



### LS

LS has style that moves you, and enough room to move nearly everyone and everything else in your life.

- Standard Chevy Safety Assist<sup>1</sup>
- 3.6L V6 engine and 9-speed automatic transmission
- Automatic Stop/Start with override
- Driver Mode Selector
- Dual-outlet exhaust with circular bright tips
- 18-inch Bright Silver-painted aluminum wheels
- Heated power-adjustable mirrors
- 8-passenger seating
- Premium Cloth seating surfaces
- Tri-zone automatic climate controls
- Tilt and telescopic steering column
- Keyless Open and Start
- Chevrolet Infotainment 3 system<sup>2</sup> with 7-inch diagonal color touch-screen
- Six USB ports,<sup>3</sup> two in each row

Midnight/Sport Edition available



### LT Cloth

Good looks are on full display, but it's the additional driver assistance features you'll truly appreciate.

- Standard Chevy Safety Assist<sup>1</sup>
- Chrome-accented grille with chrome inserts
- Black roof rails
- Body-color mirrors with turn signal indicators
- 18-inch Bright Silver-painted aluminum wheels
- 8-way power driver seat with power lumbar control
- 7-passenger or available 8-passenger seating
- 7-passenger seating includes second-row captain's chairs
- Lane Change Alert with Side Blind Zone Alert<sup>4</sup>
- Rear Cross Traffic Alert<sup>4</sup>

Midnight/Sport Edition available



### LT Leather

Elevated comfort and convenience is exactly what you can expect from Traverse LT Leather.

- Standard Chevy Safety Assist<sup>1</sup>
- Programmable power liftgate
- Remote vehicle starter system
- 7-passenger or available 8-passenger seating
- Leather-appointed front and second-row seating surfaces
- 6-way power front passenger seat with power lumbar control
- Chevrolet Infotainment 3 Plus system<sup>2</sup> with 8-inch diagonal color touch-screen
- Driver Information Center with 4.2-inch diagonal enhanced multi-color display
- Universal Home Remote programmable transmitter

Midnight/Sport Edition available

<sup>1</sup> Chevy Safety Assist includes Automatic Emergency Braking, Front Pedestrian Braking, Lane Keep Assist with Lane Departure Warning, Forward Collision Alert, IntelliBeam and Following Distance Indicator. Safety or driver assistance features are no substitute for the driver's responsibility to operate the vehicle in a safe manner. Read the vehicle Owner's Manual for important feature limitations and information. <sup>2</sup> Chevrolet Infotainment System functionality varies by model. Full functionality requires compatible Bluetooth and smartphone, and USB connectivity for some devices. <sup>3</sup> Not compatible with all devices. <sup>4</sup> Safety or driver assistance features are no substitute for the driver's responsibility to operate the vehicle in a safe manner. Read the vehicle Owner's Manual for important feature limitations and information.

## Six models to choose from.



### RS

Street-smart style, numerous driver assistance features and entertainment upgrades define RS.

- Standard Chevy Safety Assist<sup>1</sup>
- Black Chevrolet bowtie emblems, Traverse badges, grille, fog lamp bezels and window trim
- 20-inch dark aluminum wheels
- Heated power-adjustable, power-folding mirrors
- Exclusive Jet Black interior with Spice Red accents
- Perforated leather-appointed front and second-row seating surfaces
- Adaptive Cruise Control<sup>2</sup>
- Enhanced Automatic Emergency Braking<sup>2</sup>
- HD Surround Vision<sup>2</sup>
- Rear Camera Mirror<sup>2</sup> with washer
- Rear Pedestrian Alert<sup>2</sup>
- Bose premium 10-speaker sound system
- Chevrolet Infotainment 3 Plus system<sup>3</sup> with Navigation<sup>4</sup> and 8-inch diagonal HD color touch-screen



### Premier

Sophistication and style both take a big step forward in Premier.

- Standard Chevy Safety Assist<sup>1</sup>
- 20-inch metallic machined-face aluminum wheels
- Dual-outlet exhaust with rectangular bright tips
- Hands-free programmable power liftgate
- Chrome door handles and roof rails
- Body-color moldings with chrome inserts
- Three interior color options, including exclusive Jet Black with Maple Sugar accents
- Safety Alert Seat<sup>2</sup>
- Power tilt and telescopic steering column
- Driver Information Center with 8-inch diagonal enhanced multi-color display

Redline Edition available



### High Country

Expect the very best Traverse has to offer when you enter High Country.

- Standard Chevy Safety Assist<sup>1</sup>
- Trailing equipment including heavy-duty cooling system, trailer hitch and Hitch Guidance with Hitch View<sup>2</sup>
- Unique front grille
- 20-inch polished-aluminum wheels
- High Country door badging
- Bright front sill plates
- SkyScape dual-panel sunroof and fixed rear skylight with power rear sunscreen
- Heated and ventilated front seats
- Exclusive Jet Black interior with Clove accents
- Floor mats with High Country logo on front mats

<sup>1</sup> Chevy Safety Assist includes Automatic Emergency Braking, Front Pedestrian Braking, Lane Keep Assist with Lane Departure Warning, Forward Collision Alert, IntelliBeam and Following Distance Indicator. Safety or driver assistance features are no substitute for the driver's responsibility to operate the vehicle in a safe manner. Read the vehicle Owner's Manual for important feature limitations and information. <sup>2</sup> Safety or driver assistance features are no substitute for the driver's responsibility to operate the vehicle in a safe manner. Read the vehicle Owner's Manual for important feature limitations and information. <sup>3</sup> Chevrolet Infotainment System functionality varies by model. Full functionality requires compatible Bluetooth and smartphone, and USB connectivity for some devices. <sup>4</sup> Map coverage available in the United States, Puerto Rico and Canada.

# LS



Summit White



Sterling Gray Metallic



Northsky Blue Metallic



Mosaic Black Metallic

## LS



Select standard features:

**MECHANICAL**

Engine – 3.6L DOHC V6 with Variable Valve Timing (VVT), Direct Injection and Automatic Stop/Start with override

Transmission – 9-speed automatic, electronically controlled with overdrive and Driver Shift Control

**EXTERIOR**

Glass – deep-tinted rear windows and liftgate

Headlamps – LED, automatic on/off with automatic delay

Liftgate – manual

Mirrors – heated, power-adjustable, manual-folding with Black caps

**INTERIOR**

Air conditioning – automatic, tri-zone with humidity sensor and individual climate settings for driver, front passenger and rear passengers

Audio – 6-speaker system

Cruise control – electronic with Set and Resume Speed

Entertainment – Chevrolet Infotainment 3 system<sup>1</sup> with 7-inch diagonal color touch-screen

Keyless Open and Start – includes extended-range Remote Keyless Entry and panic feature

Media – two USB ports<sup>2</sup> in first row, auxiliary input jack in front center stack storage area, two charge-only USB ports<sup>2</sup> in second row and two charge-only USB ports<sup>2</sup> in third row

Rear Vision Camera<sup>3</sup>

Seat – driver 6-way manual adjuster

Seating – 8-passenger with front bucket seats and second- and third-row manual-folding 60/40 split-bench seats

SiriusXM<sup>®4</sup> – 3-month Platinum Plan trial subscription

Steering column – manual tilt and telescopic

Steering wheel – mounted audio, cruise and phone controls



Jet Black/Chai Premium Cloth



18" Bright Silver-Painted Aluminum Wheels  
Standard on LS



18" Gloss Black-Painted Aluminum Wheels  
Available on LS with Midnight/Sport Edition

<sup>1</sup> Chevrolet Infotainment System functionality varies by model. Full functionality requires compatible Bluetooth and smartphone, and USB connectivity for some devices. <sup>2</sup> Not compatible with all devices. <sup>3</sup> Safety or driver assistance features are no substitute for the driver's responsibility to operate the vehicle in a safe manner. Read the vehicle Owner's Manual for important feature limitations and information. <sup>4</sup> If you decide to continue service after your trial, your selected subscription plan will automatically renew thereafter. You will be charged at then-current rates. Fees and taxes apply. To cancel you must call SiriusXM at 1-866-635-2349. See SiriusXM Customer Agreement for complete terms at [siriusxm.com](http://siriusxm.com). All fees and programming subject to change.



# LT Cloth



Summit White



Iridescent Pearl Tricoat<sup>1</sup>



Sterling Gray Metallic



Silver Sage Metallic



Radiant Red Tintcoat<sup>1</sup>



Black Cherry Metallic



Northsky Blue Metallic



Mosaic Black Metallic

<sup>1</sup>Extra-cost color.



## LT Cloth



Select standard features:

### EXTERIOR

Glass – deep-tinted rear windows and liftgate

Headlamps – LED, automatic on/off with automatic delay

Liftgate – manual

Mirrors – heated, power-adjustable, manual-folding with body-color caps and integrated turn signal indicators

Roof rails – Black

### INTERIOR

Air conditioning – automatic, tri-zone with humidity sensor and individual climate settings for driver, front passenger and rear passengers

Audio – 6-speaker system

Cruise control – electronic with Set and Resume Speed

Entertainment – Chevrolet Infotainment 3 system<sup>1</sup> with 7-inch diagonal color touch-screen

Keyless Open and Start – includes extended-range Remote Keyless Entry and panic feature

Lane Change Alert with Side Blind Zone Alert<sup>2</sup>

Rear Cross Traffic Alert<sup>2</sup>

Rear Vision Camera<sup>2</sup>

Seat – driver 8-way power adjuster with power lumbar control

Seating – 7-passenger with front bucket seats, second-row captain's chairs and third-row manual-folding 60/40 split-bench seat

SiriusXM<sup>®3</sup> – 3-month Platinum Plan trial subscription

Steering column – manual tilt and telescopic

Steering wheel – wrapped, with mounted audio, cruise and phone controls

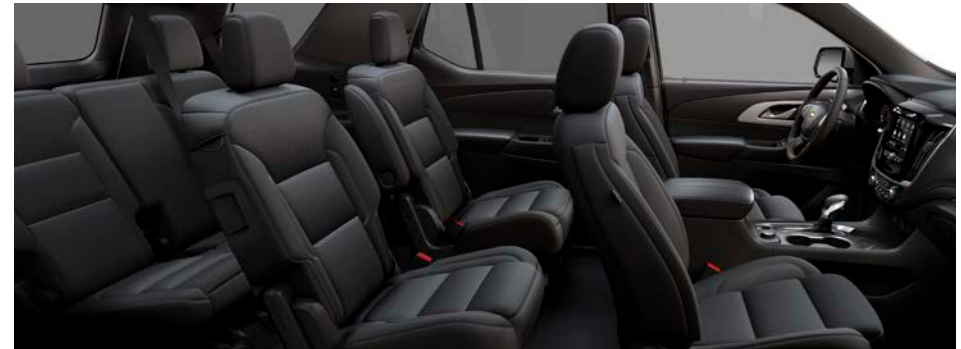

Jet Black/Chai Premium Cloth



Jet Black Premium Cloth (shown)



18" Bright Silver-Painted Aluminum Wheels  
Standard on LT Cloth



18" Gloss Black-Painted Aluminum Wheels  
Available on LT Cloth with Midnight/Sport Edition

<sup>1</sup> Chevrolet Infotainment System functionality varies by model. Full functionality requires compatible Bluetooth and smartphone, and USB connectivity for some devices. <sup>2</sup> Safety or driver assistance features are no substitute for the driver's responsibility to operate the vehicle in a safe manner. Read the vehicle Owner's Manual for important feature limitations and information. <sup>3</sup> If you decide to continue service after your trial, your selected subscription plan will automatically renew thereafter. You will be charged at then-current rates. Fees and taxes apply. To cancel you must call SiriusXM at 1-866-635-2349. See SiriusXM Customer Agreement for complete terms at [siriusxm.com](http://siriusxm.com). All fees and programming subject to change.

# LT Leather



Summit White



Iridescent Pearl Tricoat<sup>1</sup>



Sterling Gray Metallic



Silver Sage Metallic



Radiant Red Tintcoat<sup>1</sup>



Black Cherry Metallic



Northsky Blue Metallic



Mosaic Black Metallic

<sup>1</sup>Extra-cost color.

## LT Leather



Select standard features:

### EXTERIOR

Liftgate – power, programmable

Mirrors – heated, power-adjustable, manual-folding with body-color caps and integrated turn signal indicators

Roof rails – Black

### INTERIOR

Air conditioning – automatic, tri-zone with humidity sensor and individual climate settings for driver, front passenger and rear passengers

Audio – 6-speaker system

Cruise control – electronic with Set and Resume Speed

Entertainment – Chevrolet Infotainment 3 Plus system<sup>1</sup> with 8-inch diagonal HD color touch-screen

HD Rear Vision Camera<sup>2</sup>

Keyless Open and Start – includes extended-range Remote Keyless Entry and panic feature

Lane Change Alert with Side Blind Zone Alert<sup>2</sup>

Rear Cross Traffic Alert<sup>2</sup>

Remote vehicle starter system

Seat – driver 8-way power adjuster with power lumbar control  
– front passenger 6-way power adjuster with power lumbar control

SiriusXM<sup>®</sup> with 360L<sup>3</sup> – 3-month Platinum Plan trial subscription

Steering wheel – heated, wrapped, with mounted audio, cruise and phone controls

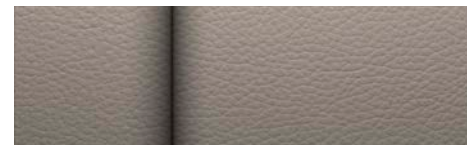

Jet Black/Chai Leather-Appointed Seating Surfaces (shown)

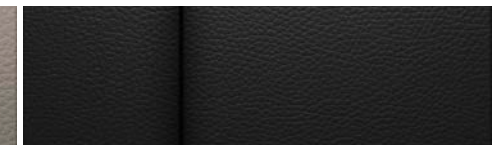

Jet Black Leather-Appointed Seating Surfaces



18" Bright Silver-Painted Aluminum Wheels  
Standard on LT Leather



18" Gloss Black-Painted Aluminum Wheels  
Available on LT Leather with Midnight/Sport Edition



20" Bright Machined-Face Aluminum Wheels  
with Painted Pockets  
Available on LT Leather with LT Premium Package

<sup>1</sup> Chevrolet Infotainment System functionality varies by model. Full functionality requires compatible Bluetooth and smartphone, and USB connectivity for some devices. <sup>2</sup> Safety or driver assistance features are no substitute for the driver's responsibility to operate the vehicle in a safe manner. Read the vehicle Owner's Manual for important feature limitations and information. <sup>3</sup> If you decide to continue service after your trial, your selected subscription plan will automatically renew thereafter. You will be charged at then-current rates. Fees and taxes apply. To cancel you must call SiriusXM at 1-866-635-2349. See SiriusXM Customer Agreement for complete terms at [siriusxm.com](http://siriusxm.com). All fees and programming subject to change. Certain features require a SiriusXM subscription and the Chevrolet Connected Access plan. See [siriusxm.com](http://siriusxm.com) and [onstar.com](http://onstar.com) for details and limitations.

# RS



Summit White



Iridescent Pearl Tricoat<sup>1</sup>



Sterling Gray Metallic



Radiant Red Tintcoat<sup>1</sup>



Mosaic Black Metallic

<sup>1</sup>Extra-cost color.



## RS



Select standard features:

**EXTERIOR**

Liftgate – power, programmable

Mirrors – heated, power-adjustable, power-folding with body-color caps and integrated turn signal indicators

RS accents – Black accents including Black roof rails, Black Chevrolet bowtie emblems, Black Traverse badges, gloss Black window trim and Black Ice grille

**INTERIOR**

Adaptive Cruise Control<sup>1</sup>

Audio – Bose premium 10-speaker sound system with Richbass woofer under center console

Enhanced Automatic Emergency Braking<sup>1</sup>

Entertainment – Chevrolet Infotainment 3 Plus system<sup>2</sup> with Navigation<sup>3</sup>

HD Surround Vision<sup>1</sup> – includes HD Rear Vision Camera<sup>1</sup>

Keyless Open and Start – includes extended-range Remote Keyless Entry and panic feature

Lane Change Alert with Side Blind Zone Alert<sup>1</sup>

Power outlet – 120-volt on rear of center console

Rear Camera Mirror<sup>1</sup> – with washer, auto-dimming with full camera display

Rear Cross Traffic Alert<sup>1</sup>

Rear Pedestrian Alert<sup>1</sup>

Remote vehicle starter system

SiriusXM<sup>®</sup> with 360L<sup>4</sup> – 3-month Platinum Plan trial subscription

Steering wheel – heated, wrapped, with mounted audio, cruise and phone controls

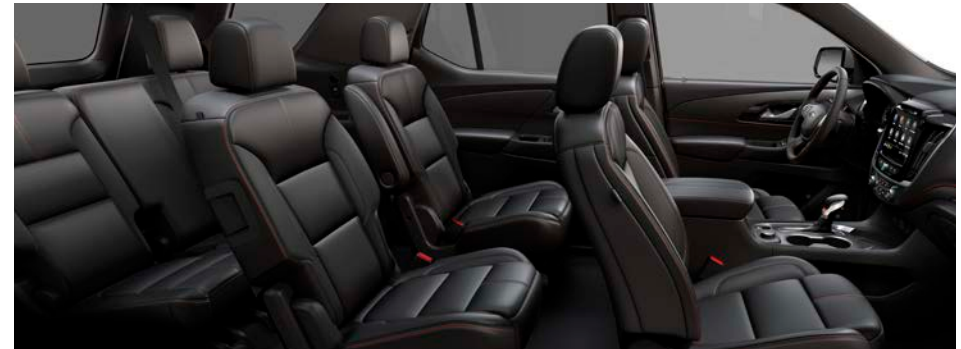

Jet Black/Spice Red Perforated Leather-Appointed Seating Surfaces



20" Dark Aluminum Wheels  
Standard on RS

<sup>1</sup> Safety or driver assistance features are no substitute for the driver's responsibility to operate the vehicle in a safe manner. Read the vehicle Owner's Manual for important feature limitations and information. <sup>2</sup> Chevrolet Infotainment System functionality varies by model. Full functionality requires compatible Bluetooth and smartphone, and USB connectivity for some devices. <sup>3</sup> Map coverage available in the United States, Puerto Rico and Canada. <sup>4</sup> If you decide to continue service after your trial, your selected subscription plan will automatically renew thereafter. You will be charged at then-current rates. Fees and taxes apply. To cancel you must call SiriusXM at 1-866-635-2349. See SiriusXM Customer Agreement for complete terms at [siriusxm.com](http://siriusxm.com). All fees and programming subject to change. Certain features require a SiriusXM subscription and the Chevrolet Connected Access plan. See [siriusxm.com](http://siriusxm.com) and [onstar.com](http://onstar.com) for details and limitations.

Some features shown may have limited, late or no availability. See dealer for feature availability.

# Premier



Summit White



Iridescent Pearl Tricoat<sup>1</sup>



Sterling Gray Metallic



Radiant Red Tintcoat<sup>1</sup>



Black Cherry Metallic



Mosaic Black Metallic

<sup>1</sup>Extra-cost color.

# Premier



Select standard features:

## EXTERIOR

Liftgate – power, programmable, hands-free with Chevrolet emblem projection

Mirrors – heated, power-adjustable, power-folding with body-color caps, integrated turn signal indicators and driver-side auto-dimming feature

Roof rails – chrome

## INTERIOR

Adaptive Cruise Control<sup>1</sup>

Audio – Bose premium 10-speaker sound system with Richbass woofer under center console

Enhanced Automatic Emergency Braking<sup>1</sup>

Entertainment – Chevrolet Infotainment 3 Plus system<sup>2</sup> with Navigation<sup>3</sup>

HD Surround Vision<sup>1</sup> – includes HD Rear Vision Camera<sup>1</sup>

Keyless Open and Start – includes extended-range Remote Keyless Entry and panic feature

Lane Change Alert with Side Blind Zone Alert<sup>1</sup>

Memory settings – recalls two presets for power driver seat, exterior mirrors, and power tilt and telescopic steering column

Rear Camera Mirror<sup>1</sup> – with washer, auto-dimming with full camera display

Rear Cross Traffic Alert<sup>1</sup>

Rear Pedestrian Alert<sup>1</sup>

Remote vehicle starter system

Safety Alert Seat<sup>1</sup>

SiriusXM<sup>®</sup> with 360L<sup>4</sup> – 3-month Platinum Plan trial subscription

Steering column – power tilt and telescopic

Steering wheel – heated, wrapped, with mounted audio, cruise and phone controls

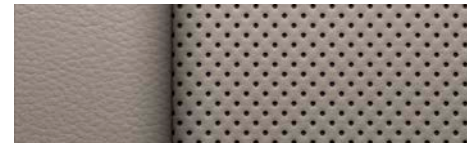

Jet Black/Chai Perforated Leather-Appointed Seating Surfaces with Sueded Microfiber Inserts

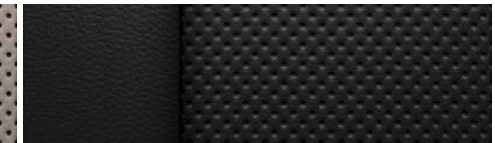

Jet Black Perforated Leather-Appointed Seating Surfaces with Sueded Microfiber Inserts



Maple Sugar Perforated Leather-Appointed Seating Surfaces with Sueded Microfiber Inserts (shown)



20" Metallic Machined-Face Aluminum Wheels  
Standard on Premier



20" Gloss Black-Painted Aluminum Wheels with Red Accents  
Available on Premier with Redline Edition

<sup>1</sup> Safety or driver assistance features are no substitute for the driver's responsibility to operate the vehicle in a safe manner. Read the vehicle Owner's Manual for important feature limitations and information. <sup>2</sup> Chevrolet Infotainment System functionality varies by model. Full functionality requires compatible Bluetooth and smartphone, and USB connectivity for some devices. <sup>3</sup> Map coverage available in the United States, Puerto Rico and Canada. <sup>4</sup> If you decide to continue service after your trial, your selected subscription plan will automatically renew thereafter. You will be charged at then-current rates. Fees and taxes apply. To cancel you must call SiriusXM at 1-866-635-2349. See SiriusXM Customer Agreement for complete terms at [siriusxm.com](http://siriusxm.com). All fees and programming subject to change. Certain features require a SiriusXM subscription and the Chevrolet Connected Access plan. See [siriusxm.com](http://siriusxm.com) and [onstar.com](http://onstar.com) for details and limitations.

Some features shown may have limited, late or no availability. See dealer for feature availability.

# High Country



Summit White



Iridescent Pearl Tricoat<sup>1</sup>



Sterling Gray Metallic



Radiant Red Tintcoat<sup>1</sup>



Black Cherry Metallic



Mosaic Black Metallic

<sup>1</sup>Extra-cost color.



# High Country



Select standard features:

## EXTERIOR

Liftgate – power, programmable, hands-free with Chevrolet emblem projection

Mirrors – heated, power-adjustable, power-folding with body-color caps, integrated turn signal indicators and driver-side auto-dimming feature

Roof rails – chrome

## INTERIOR

Adaptive Cruise Control<sup>1</sup>

Audio – Bose premium 10-speaker sound system with Richbass woofer under center console

Enhanced Automatic Emergency Braking<sup>1</sup>

Entertainment – Chevrolet Infotainment 3 Plus system<sup>2</sup> with Navigation<sup>3</sup>

HD Surround Vision<sup>1</sup> – includes HD Rear Vision Camera<sup>1</sup>

Lane Change Alert with Side Blind Zone Alert<sup>1</sup>

Memory settings – recalls two presets for power driver seat, exterior mirrors, and power tilt and telescopic steering column

Rear Camera Mirror<sup>1</sup> – with washer, auto-dimming with full camera display

Rear Pedestrian Alert<sup>1</sup>

Remote vehicle starter system

Safety Alert Seat<sup>1</sup>

Seats – heated and ventilated driver and front passenger

SiriusXM<sup>®</sup> with 360L<sup>4</sup> – 3-month Platinum Plan trial subscription

Steering column – power tilt and telescopic

Steering wheel – heated, wrapped, with mounted audio, cruise and phone controls

Sunroof – SkyScape, power tilt-sliding front with fixed rear skylight and sunscreen

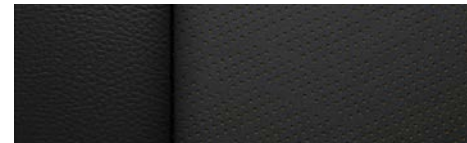
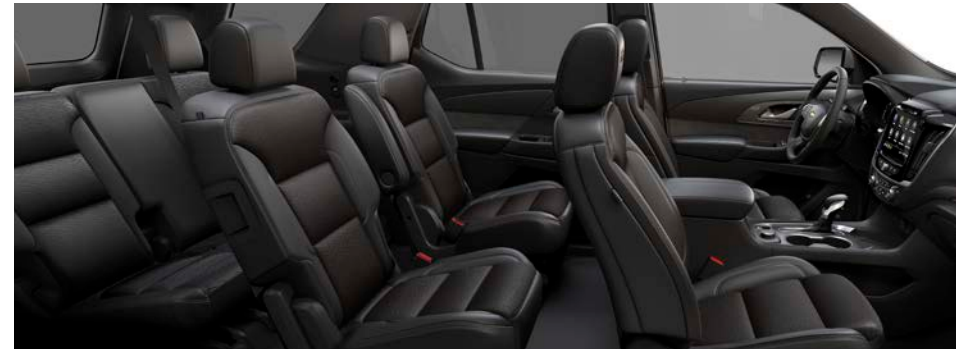

Jet Black/Clove Perforated Leather-Appointed Seating Surfaces



20" Polished-Aluminum Wheels  
Standard on High Country

<sup>1</sup> Safety or driver assistance features are no substitute for the driver's responsibility to operate the vehicle in a safe manner. Read the vehicle Owner's Manual for important feature limitations and information. <sup>2</sup> Chevrolet Infotainment System functionality varies by model. Full functionality requires compatible Bluetooth and smartphone, and USB connectivity for some devices. <sup>3</sup> Map coverage available in the United States, Puerto Rico and Canada. <sup>4</sup> If you decide to continue service after your trial, your selected subscription plan will automatically renew thereafter. You will be charged at then-current rates. Fees and taxes apply. To cancel you must call SiriusXM at 1-866-635-2349. See SiriusXM Customer Agreement for complete terms at [siriusxm.com](http://siriusxm.com). All fees and programming subject to change. Certain features require a SiriusXM subscription and the Chevrolet Connected Access plan. See [siriusxm.com](http://siriusxm.com) and [onstar.com](http://onstar.com) for details and limitations.

● STANDARD ○ AVAILABLE – NOT AVAILABLE

	LS	LT CLOTH	LT LEATHER	RS	PREMIER	HIGH COUNTRY
<b>SAFETY AND DRIVER ASSISTANCE</b>						
<b>Chevy Safety Assist<sup>1</sup></b>	●	●	●	●	●	●
Automatic Emergency Braking						
Front Pedestrian Braking						
Lane Keep Assist with Lane Departure Warning						
Forward Collision Alert						
IntelliBeam, auto high beams						
Following Distance Indicator						
<b>Airbags<sup>2</sup></b> – frontal airbags for driver and front passenger; seat-mounted side-impact airbags for driver and front passenger; driver inboard seat-mounted side-impact airbag; head-curtain airbags for all rows in outboard seating positions; includes Passenger Sensing System for passenger-side frontal airbag	●	●	●	●	●	●
<b>Buckle to Drive</b>	●	●	●	●	●	●
<b>Enhanced Automatic Emergency Braking<sup>1</sup></b> (replaces Automatic Emergency Braking; requires available LT Premium Package on LT Leather)	–	–	○	●	●	●
<b>Lane Change Alert with Side Blind Zone Alert<sup>1</sup></b> (requires available Safety Package on LS)	○	●	●	●	●	●
<b>LATCH system (Lower Anchors and Tethers for CHildren)</b> – for child restraint systems	●	●	●	●	●	●
<b>Rear Cross Traffic Alert<sup>1</sup></b> (requires available Safety Package on LS)	○	●	●	●	●	●
<b>Rear Park Assist<sup>1</sup></b> (requires available Safety Package on LS; feature will not function on certain models without dealer retrofit; see dealer or window label for details)	○	○	○	○	○	○
<b>Rear Pedestrian Alert<sup>1</sup></b> (requires available HD Surround Vision on LT Cloth and LT Leather)	–	○	○	●	●	●
<b>Rear Vision Camera<sup>1</sup></b>	●	●	–	–	–	–
<b>HD Rear Vision Camera<sup>1</sup></b> (included on LT Cloth AWD; requires available Convenience and Driver Confidence Package on LT Cloth FWD)	–	○	●	●	●	●
<b>HD Surround Vision<sup>1</sup></b> (requires available Rear Camera Mirror <sup>1</sup> and Convenience and Driver Confidence Package on LT Cloth; requires available Rear Camera Mirror <sup>1</sup> and LT Premium Package on LT Leather)	–	○	○	●	●	●
<b>Safety Alert Seat<sup>1</sup></b>	–	–	–	–	●	●
<b>Teen Driver technology<sup>1</sup></b>	●	●	●	●	●	●
<b>Theft-deterrent system</b> – unauthorized entry	●	●	●	●	●	●
<b>Tire Pressure Monitoring System</b> – with Tire Fill Alert (does not monitor spare tire)	●	●	●	●	●	●
<b>Up to 3 months of OnStar<sup>®</sup> Safety &amp; Security coverage<sup>3</sup></b>	●	●	●	●	●	●

	LS	LT CLOTH	LT LEATHER	RS	PREMIER	HIGH COUNTRY
<b>MECHANICAL</b>						
<b>All-wheel drive (AWD)</b> – on/off switchable	○	○	○	○	○	○
<b>Brakes</b> – 4-wheel antilock, 4-wheel disc with Duralife <sup>®</sup> rotors; electronic parking brake	●	●	●	●	●	●
<b>Cooling system</b> – heavy-duty (requires available trailering equipment on LT Cloth, LT Leather, RS and Premier)	–	○	○	○	○	●
<b>Driver Mode Selector</b>	●	●	●	●	●	●
<b>Engine</b> – 3.6L DOHC V6 with Variable Valve Timing (VVT), Direct Injection and Automatic Stop/Start with override; 310 hp @ 6800 rpm, 266 lb.-ft. of torque @ 2800 rpm	●	●	●	●	●	●
<b>Exhaust</b> – aluminized stainless steel	●	●	●	●	●	●
– dual-outlet with circular bright tips	●	●	●	●	–	–
– dual-outlet with rectangular bright tips	–	–	–	–	●	●
<b>Hitch Guidance<sup>1</sup></b> (requires available trailering equipment on LT Cloth, LT Leather, RS and Premier)	–	○	○	○	○	●
<b>Hitch View<sup>1</sup></b> (requires available trailering equipment and Convenience and Driver Confidence Package on LT Cloth FWD; requires available trailering equipment on LT Cloth AWD, LT Leather, RS and Premier)	–	○	○	○	○	●
<b>StabiliTrak<sup>®</sup></b> – Electronic Stability Control System with Traction Control; includes Hill Start Assist	●	●	●	●	●	●
<b>Steering</b> – power, electric variable-effort, rack-and-pinion with Active Return Assist	●	●	●	●	●	●
<b>Suspension</b> – front MacPherson strut	●	●	●	●	●	●
– rear 5-link, independent	●	●	●	●	●	●
<b>Trailering equipment</b> – heavy-duty cooling system, trailer hitch and Hitch Guidance <sup>1</sup> (includes Hitch View <sup>1</sup> with available Convenience and Driver Confidence Package on LT Cloth FWD; includes Hitch View <sup>1</sup> on LT Cloth AWD, LT Leather, RS, Premier and High Country)	–	○	○	○	○	●
<b>Transmission</b> – 9-speed automatic, electronically controlled with overdrive and Driver Shift Control	●	●	●	●	●	●

<sup>1</sup> Safety or driver assistance features are no substitute for the driver's responsibility to operate the vehicle in a safe manner. Read the vehicle Owner's Manual for important feature limitations and information. <sup>2</sup> A NOTE ON CHILD SAFETY: Always use seat belts and the correct child restraint for your child's age and size, even with airbags. Even in vehicles equipped with the Passenger Sensing System, children are safer when properly secured in a rear seat in the appropriate infant, child or booster seat. Never place a rear-facing infant restraint in the front seat of any vehicle equipped with an active frontal airbag. See your vehicle Owner's Manual and the child safety seat instructions for more safety information. <sup>3</sup> When you select a monthly plan within 30 days of activating your 1-month trial, you'll receive the next 2 months of the plan you select at no additional charge when you associate an approved payment method on file to your account and authorize recurring payments for your service plan. The amount and frequency of each recurring payment is based upon the service(s) and payment interval(s) you select from the options provided. After the trial expires, OnStar will automatically bill your payment method monthly at then-current standard monthly rates. Plans containing 4G LTE data will be billed every 30 days by AT&T. You may cancel at any time by pushing your blue OnStar button or calling 1-888-466-7827. May not be combined with other offers or retroactively applied. Offer subject to change.

● STANDARD ○ AVAILABLE – NOT AVAILABLE

	LS	LT CLOTH	LT LEATHER	RS	PREMIER	HIGH COUNTRY
<b>EXTERIOR</b>						
Active aero shutters – upper and lower – upper (requires available LT Premium Package on LT Leather)	●	●	●	–	–	–
Chevrolet bowtie emblems – Black (requires available Midnight/Sport Edition on LS, LT Cloth and LT Leather; requires available Redline Edition on Premier)	○	○	○	●	○	–
Daytime running lamps – LED	●	●	●	●	●	●
Door handles – body-color – bright chrome – Black (requires available Redline Edition)	●	●	●	●	–	–
Fuel filler – capless fueling	●	●	●	●	●	●
Glass – deep-tinted rear windows and liftgate	●	●	●	●	●	●
Headlamps – LED, automatic on/off with automatic delay	●	●	●	●	●	●
Liftgate – manual – power, programmable (requires available Convenience and Driver Confidence Package on LT Cloth FWD; included on LT Cloth AWD) – power, programmable, hands-free with Chevrolet emblem projection	●	●	–	–	–	–
Mirrors – heated, power-adjustable, manual-folding – heated, power-adjustable, manual-folding with integrated turn signal indicators (requires available Safety Package on LS) – heated, power-adjustable, power-folding with integrated turn signal indicators (requires available LT Premium Package on LT Leather) – heated, power-adjustable, power-folding with integrated turn signal indicators and driver-side auto-dimming feature – Black caps – Black caps with Red accents (requires available Redline Edition) – body-color caps	●	●	–	–	–	–

	LS	LT CLOTH	LT LEATHER	RS	PREMIER	HIGH COUNTRY
<b>EXTERIOR (CONTINUED)</b>						
Moldings – Black bodyside and rocker – body-color with chrome inserts	●	●	●	●	–	–
Roof rails – Black (requires available Midnight/Sport Edition on LS; requires available Redline Edition on Premier) – chrome	○	●	●	●	○	–
Taillamps – LED	●	●	●	●	●	●
Tires – P255/65R18 all-season – P255/55R20 all-season (requires available 20" bright machined-face aluminum wheels with painted pockets on LT Leather) – compact spare	●	●	●	–	–	–
Wheels – 18" Bright Silver-painted aluminum – 18" Bright Silver-painted aluminum – 18" gloss Black-painted aluminum (requires available Midnight/Sport Edition) – 20" bright machined-face aluminum with painted pockets (requires available LT Premium Package) – 20" dark aluminum – 20" metallic machined-face aluminum – 20" gloss Black-painted aluminum with Red accents (requires available Redline Edition) – 20" polished-aluminum	●	–	–	–	–	–
Wipers – front variable-speed, intermittent; rear intermittent with washer	●	●	●	●	●	●

● STANDARD ○ AVAILABLE – NOT AVAILABLE

	LS	LT CLOTH	LT LEATHER	RS	PREMIER	HIGH COUNTRY
<b>INTERIOR</b>						
Active Noise Cancellation	●	●	●	●	●	●
Air conditioning – automatic, tri-zone with humidity sensor and individual climate settings for driver, front passenger and rear passengers	●	●	●	●	●	●
Cargo area – underfloor hidden storage	●	●	●	●	●	●
Cruise control – electronic with Set and Resume Speed	●	●	●	–	–	–
– Adaptive Cruise Control <sup>1</sup> with Enhanced Automatic Emergency Braking <sup>1</sup> (requires available LT Premium Package on LT Leather)	–	–	○	●	●	●
Defogger – electric rear-window	●	●	●	●	●	●
Door locks – power programmable with lockout protection and manual rear door child security	●	●	●	●	●	●
Driver Information Center – 3.5-inch diagonal monochromatic display (standard on LT Cloth FWD)	●	●	–	–	–	–
– 4.2-inch diagonal enhanced multi-color display (requires available Convenience and Driver Confidence Package on LT Cloth FWD; standard on LT Cloth AWD)	–	○	●	●	–	–
– enhanced 8-inch diagonal reconfigurable multi-color display	–	–	–	–	●	●
– digital compass	●	●	●	●	●	●
Floor mats – all rows, carpeted	●	●	●	●	●	–
– all rows, carpeted with High Country logo on first-row mats	–	–	–	–	–	●
Keyless Open and Start – includes extended-range Remote Keyless Entry and panic feature	●	●	●	●	●	●
Lighting – interior lighting with illuminated entry/exit, theater dimming, cargo area, first-row and second-row reading lamps, and door- and tailgate-activated switches	●	●	●	●	●	●
Memory settings – recalls two presets for power driver seat, exterior mirrors, and power tilt and telescopic steering column	–	–	–	–	●	●
Mirror – rearview, manual day/night	●	●	●	–	–	–
– Rear Camera Mirror, <sup>2</sup> auto-dimming with full camera display and camera washer (requires available Convenience and Driver Confidence Package on LT Cloth)	–	○	○	●	●	●
Power outlet – 120-volt, on rear of center console (requires available LT Premium Package on LT Leather)	–	–	○	●	●	●
Rear Seat Reminder <sup>2</sup>	●	●	●	●	●	●
Remote vehicle starter system (requires available Convenience and Driver Confidence Package on LT Cloth FWD; standard on LT Cloth AWD)	–	○	●	●	●	●
Sill plates – front, bright	–	–	–	–	–	●
Steering column – manual tilt and telescopic	●	●	●	●	–	–
– power tilt and telescopic	–	–	–	–	●	●

	LS	LT CLOTH	LT LEATHER	RS	PREMIER	HIGH COUNTRY
<b>INTERIOR (CONTINUED)</b>						
Steering wheel – mounted audio, cruise and phone controls	●	–	–	–	–	–
– wrapped, with mounted audio, cruise and phone controls	–	●	●	●	●	●
– heated with selectable automatic activation	–	–	●	●	●	●
Sunroof – SkyScape, power tilt-sliding front with fixed rear skylight and sunscreen (requires available LT Premium Package on LT Leather; requires available AWD on RS)	–	–	○	○	○	●
Umbrella holders – front doors	●	●	●	●	●	●
Universal Home Remote – programmable, includes garage door opener (requires available Convenience and Driver Confidence Package on LT Cloth FWD; standard on LT Cloth AWD)	–	○	●	●	●	●
Visors – driver and front passenger illuminated vanity mirrors, covered	●	●	●	●	●	●
Windows – power with driver express-up/-down and front passenger express-down	●	●	●	●	●	●
<b>SEATING</b>						
Seating – 8-passenger with front bucket seats and second- and third-row manual-folding 60/40 split-bench seats (requires available Jet Black leather-appointed seating on LT Leather)	●	○	○	–	–	–
– 7-passenger with front bucket seats, second-row captain's chairs and third-row manual-folding 60/40 split-bench seat (third-row power-folding 60/40 split-bench seat standard on High Country)	–	●	●	●	●	●
Seat – driver 6-way manual adjuster	●	–	–	–	–	–
– driver 8-way power adjuster with power lumbar control	–	●	●	●	●	●
– front passenger 6-way power adjuster with power lumbar control	–	–	●	●	●	●
Seating surfaces – Premium Cloth	●	●	–	–	–	–
– leather-appointed front and second rows; third row is vinyl-covered	–	–	●	●	–	–
– perforated leather-appointed front and second rows; third row is vinyl-covered	–	–	–	–	●	–
– premium perforated leather-appointed front and second rows; third row is vinyl-covered	–	–	–	–	–	●
Heated front seats (requires available Convenience and Driver Confidence Package on LT Cloth FWD; standard on LT Cloth AWD; feature will not function on certain models without dealer retrofit; see dealer or window label for details)	–	○	○	○	○	●
Heated second-row outboard seating positions (feature will not function on certain models without dealer retrofit; see dealer or window label for details)	–	–	–	–	○	○
Ventilated front seats (feature will not function on certain models without dealer retrofit; see dealer or window label for details)	–	–	–	–	○	●

<sup>1</sup> Safety or driver assistance features are no substitute for the driver's responsibility to operate the vehicle in a safe manner. Read the vehicle Owner's Manual for important feature limitations and information. <sup>2</sup> Does not detect people or items. Always check rear seat before exiting.



● STANDARD ○ AVAILABLE – NOT AVAILABLE

	LS	LT CLOTH	LT LEATHER	RS	PREMIER	HIGH COUNTRY
<b>ENTERTAINMENT</b>						
Chevrolet Infotainment 3 system <sup>1</sup> with 7-inch diagonal color touch-screen, AM/FM stereo, Bluetooth <sup>®</sup> audio streaming <sup>2</sup> for two active devices, voice command pass-through to compatible phone, and wireless Apple CarPlay <sup>®3</sup> and wireless Android Auto <sup>™4</sup> compatibility	●	●	–	–	–	–
Chevrolet Infotainment 3 Plus system <sup>1</sup> with 8-inch diagonal HD color touch-screen, motorized power-up/-down screen and hidden storage, AM/FM stereo, Bluetooth audio streaming <sup>2</sup> for two active devices, voice command pass-through to compatible phone, wireless Apple CarPlay <sup>3</sup> and wireless Android Auto <sup>4</sup> compatibility, available Alexa Built-In <sup>5</sup> ; voice recognition and available In-Vehicle Apps <sup>6</sup> (requires available Convenience and Driver Confidence Package on LT Cloth FWD; standard on LT Cloth AWD)	–	○	●	–	–	–
Chevrolet Infotainment 3 Plus system <sup>1</sup> with Navigation <sup>7</sup> and 8-inch diagonal HD color touch-screen, motorized power-up/-down screen and hidden storage, AM/FM stereo, Bluetooth audio streaming <sup>2</sup> for two active devices, voice command pass-through to compatible phone, wireless Apple CarPlay <sup>3</sup> and wireless Android Auto <sup>4</sup> compatibility, available Alexa Built-In <sup>5</sup> ; enhanced voice recognition, additional memory for available In-Vehicle Apps <sup>6</sup> and Connected Navigation <sup>8</sup> (requires available LT Premium Package on LT Leather)	–	–	○	●	●	●
Audio – 6-speaker system	●	●	●	–	–	–
– Bose premium 10-speaker sound system with Richbass woofer under center console (requires available LT Premium Package on LT Leather)	–	–	○	●	●	●
Media – two USB ports <sup>9</sup> in first row, auxiliary input jack in front center stack storage area, and two charge-only USB ports <sup>9</sup> in second and third rows	●	●	●	●	●	●
SiriusXM <sup>®10</sup> – 3-month Platinum Plan trial subscription	●	●	–	–	–	–
SiriusXM with 360L <sup>10,11</sup> – 3-month Platinum Plan trial subscription (requires available Convenience and Driver Confidence Package on LT Cloth FWD; standard on LT Cloth AWD)	–	○	●	●	●	●
Available Wi-Fi <sup>®</sup> Hotspot <sup>12</sup> for up to seven devices, includes 1 month of unlimited data	○	○	○	○	○	○
Chevrolet Connected Access <sup>13</sup> with up to 10 years of standard connectivity, which currently enables features such as Vehicle Diagnostics and Dealer Maintenance Notification	●	●	●	●	●	●
Wireless charging <sup>14</sup>	–	●	●	●	●	●

<sup>1</sup> Chevrolet Infotainment System functionality varies by model. Full functionality requires compatible Bluetooth and smartphone, and USB connectivity for some devices. <sup>2</sup> Go to [my.chevrolet.com/learnAbout/bluetooth](http://my.chevrolet.com/learnAbout/bluetooth) to find out which phones are compatible with the vehicle. Full Bluetooth feature functionality varies by device, model and software version. <sup>3</sup> Vehicle user interface is a product of Apple and its terms and privacy statements apply. Requires compatible iPhone and data plan rates apply. <sup>4</sup> Vehicle user interface is a product of Google and its terms and privacy statements apply. To use Android Auto on your car display, you'll need an Android phone running Android 6 or higher, an active data plan, and the Android Auto app. <sup>5</sup> Functionality is subject to limitations and varies by vehicle, infotainment system and location. Select service plan required. Certain Alexa Skills require account linking to use. Visit [onstar.com](http://onstar.com) for additional details. <sup>6</sup> Third-party trademarks are the property of their respective third-party owners and used under agreement. Requires active service plan and paid AT&T vehicle data plan. Visit [onstar.com](http://onstar.com) for details and limitations. <sup>7</sup> Map coverage available in the United States, Puerto Rico and Canada. <sup>8</sup> Connected Navigation and Real-time Points of Interest (POI) only available on properly equipped vehicles. Requires paid plan or trial. Map coverage available in the United States, Puerto Rico and Canada. Visit [onstar.com](http://onstar.com) for details and limitations. <sup>9</sup> Not compatible with all devices. <sup>10</sup> If you decide to continue service after your trial, your selected subscription plan will automatically renew thereafter. You will be charged at then-current rates. Fees and taxes apply. To cancel you must call SiriusXM at 1-866-635-2349. See SiriusXM Customer Agreement for complete terms at [siriusxm.com](http://siriusxm.com). All fees and programming subject to change. <sup>11</sup> Certain features require a SiriusXM subscription and the Chevrolet Connected Access plan. See [siriusxm.com](http://siriusxm.com) and [onstar.com](http://onstar.com) for details and limitations. <sup>12</sup> Service varies with conditions and location. Requires active service and paid AT&T data plan. Visit [onstar.com](http://onstar.com) for details and limitations. Availability subject to change. <sup>13</sup> Standard connectivity available only to original purchaser for up to 10 years. Connected Access services are subject to change. Does not include emergency or security services. Diagnostic capabilities vary by model and service plan. Message and data rates may apply. Requires contact method on file and enrollment to receive alerts. Not all issues will deliver alerts. Visit [onstar.com](http://onstar.com) for details and limitations. <sup>14</sup> The system wirelessly charges one compatible mobile device. Some phones have built-in wireless charging technology and others require a special adaptor/back cover. To check for phone or other device compatibility, see [my.chevrolet.com/learn](http://my.chevrolet.com/learn) or consult your carrier.



Redline Edition.



Midnight Edition.



Sport Edition.

● STANDARD ○ AVAILABLE – NOT AVAILABLE

	LS	LT CLOTH	LT LEATHER	RS	PREMIER	HIGH COUNTRY
<b>PACKAGES AND SPECIAL EDITIONS</b>						
<b>Safety Package<sup>1</sup></b>	○	–	–	–	–	–
Lane Change Alert with Side Blind Zone Alert, Rear Cross Traffic Alert and Rear Park Assist (feature will not function on certain models without dealer retrofit; see dealer or window label for details)						
<b>Convenience and Driver Confidence Package</b>	–	○	–	–	–	–
Chevrolet Infotainment 3 Plus system <sup>2</sup> ; Driver Information Center with 4.2-inch diagonal enhanced multi-color display, Universal Home Remote, remote vehicle starter system, programmable power liftgate and heated front seats (feature will not function on certain models without dealer retrofit; see dealer or window label for details) (standard on LT Cloth AWD)						
<b>LT Premium Package</b>	–	–	○	–	–	–
20" bright machined-face aluminum wheels with painted pockets, heated power-adjustable power-folding mirrors with body-color caps and integrated turn signal indicators, Chevrolet Infotainment 3 Plus system <sup>2</sup> with Navigation <sup>3</sup> ; Bose premium 10-speaker sound system with Richbass woofer under center console, Adaptive Cruise Control <sup>1</sup> ; Enhanced Automatic Emergency Braking <sup>1</sup> ; Rear Pedestrian Alert <sup>1</sup> ; Rear Camera Mirror <sup>1</sup> with washer, HD Surround Vision <sup>1</sup> and 120-volt power outlet on rear of center console						
<b>Midnight/Sport Edition</b>	○	○	○	–	–	–
18" gloss Black-painted aluminum wheels, Black roof rails, Black Traverse badges, Black Chevrolet bowtie emblems, Black liftgate appliqué, gloss Black window surround and Black Ice grille surround (requires Jet Black interior on LT Cloth and LT Leather; not available with LT Premium Package on LT Leather)						
<b>Redline Edition</b>	–	–	–	–	○	–
20" gloss Black-painted aluminum wheels with Red accents, Black Traverse badges with Red outline, Black Chevrolet bowtie emblems, Black roof rails, mirror caps and door handles, gloss Black window surround, Black-painted rocker and wheel openings with Black Ice inserts, Black Ice grille surround and license plate appliqué, SkyScape power sunroof, and trailering equipment (requires Jet Black interior; available with Summit White, Iridescent Pearl Tricoat <sup>4</sup> ; Sterling Gray Metallic, Radiant Red Tintcoat <sup>4</sup> or Mosaic Black Metallic exterior colors)						

<sup>1</sup> Safety or driver assistance features are no substitute for the driver's responsibility to operate the vehicle in a safe manner. Read the vehicle Owner's Manual for important feature limitations and information. <sup>2</sup> Chevrolet Infotainment System functionality varies by model. Full functionality requires compatible Bluetooth and smartphone, and USB connectivity for some devices. <sup>3</sup> Map coverage available in the United States, Puerto Rico and Canada. <sup>4</sup> Extra-cost color.

## MAXIMUM CAPACITIES

Fuel tank (approximate)	19.4 gallons - FWD 21.7 gallons - AWD
Passenger volume	157.1 cubic feet

Seating (first row/second row/third row)	LS seats 8 - 2/3/3 LT Cloth and LT Leather seat 7 - 2/2/3; option for 8 - 2/3/3 RS, Premier and High Country seat 7 - 2/2/3
Cargo volume <sup>1</sup>	Behind third-row seat - 23.0 cubic feet Behind second-row seat - 57.8 cubic feet Behind first-row seat - 98.2 cubic feet

## DIMENSIONS

A - Wheelbase	120.9"
B - Length	205.9"
C - Height	70.7"

D - Front track	67.3"
Rear track	67.0"
E - Width	78.6"

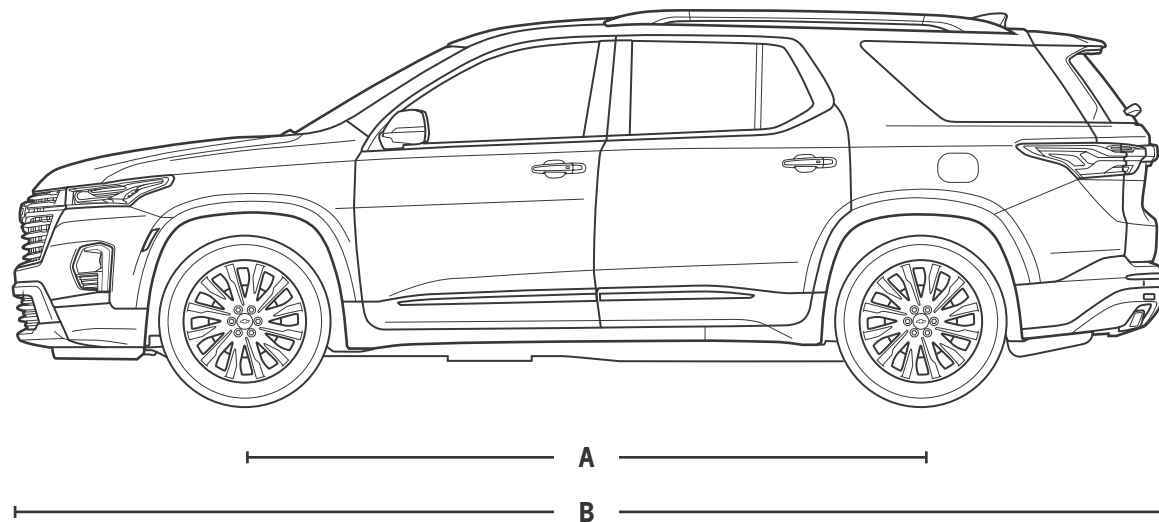

## EPA-ESTIMATED FUEL ECONOMY

3.6L FWD	18 MPG city/27 highway/21 combined
3.6L AWD	17 MPG city/25 highway/20 combined

Head room (first row/second row/third row)	42.8"/40.0"/38.2"
Head room with sunroof (first row/second row/third row)	41.4"/39.0"/38.2"
Leg room (first row/second row/third row)	41.0"/38.4"/33.5"
Shoulder room (first row/second row/third row)	61.9"/62.2"/57.5"
Hip room (first row/second row/third row)	58.1"/56.9"/48.5"

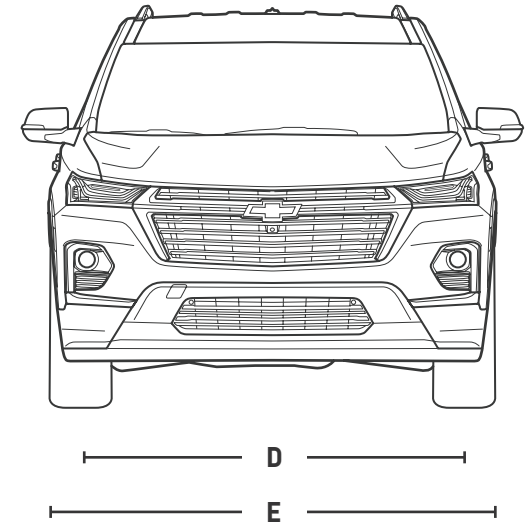

<sup>1</sup> Cargo and load capacity limited by weight and distribution.



**20" Chrome Finish Aluminum Split-Spoke Wheels available from Chevrolet Accessories.**



**Integrated Cargo Organizer available from Chevrolet Accessories.**



**Roof Rack Cross Rails available from Chevrolet Accessories.**



**Premium All-Weather Floor Liners available from Chevrolet Accessories.**





## Important information.

You may be discovering Chevrolet through a personalized online shopping experience or enjoying every year of vehicle ownership. Either way, we're committed to providing the tools and programs you need to help you get the most out of your journey.

### Build & Price >

Create your perfect Chevrolet from start to finish.

### Chevy MyWay<sup>1</sup> >

Engage in a real-time virtual video experience with a Chevy product specialist.

### Chevrolet Complete Care >

Enjoy an owner benefit program that provides excellent service and support from day one.

### My Chevrolet Rewards<sup>2</sup> >

Unlock a world of appreciation that's all about you and your Chevrolet. Start earning and redeeming today.

### Limited Warranty Coverage >

Discover all the ways Chevrolet is committed to providing an excellent ownership experience.



GM, the GM logo, Chevrolet, the Chevrolet logo, and the slogans, emblems, vehicle model names, vehicle body designs and other marks appearing in this brochure are the trademarks and/or service marks of General Motors, its subsidiaries, affiliates or licensors. ©2022 OnStar LLC. All rights reserved. Sirius, XM, SiriusXM and all related marks and logos are trademarks of Sirius XM Radio Inc. Amazon, Alexa and all related marks are trademarks of Amazon.com, Inc. or its affiliates. The Bluetooth word mark is a registered trademark owned by Bluetooth SIG, Inc., and any use of such mark by Chevrolet is under license. Bose is a registered trademark and Richbass is a trademark of the Bose Corp.

©2022 General Motors. All rights reserved. June 2022

**FIND NEW ROADS™**

**CHEVROLET.COM**

<sup>1</sup> Chevy MyWay is available to anyone over 18 in the United States to access and experience via [chevrolet.com/myway](https://chevrolet.com/myway). <sup>2</sup> Must be 18 years or older. Points may be earned and redeemed only at GM entities, My Chevrolet Rewards participating dealers or third party retailers in the United States (excluding Puerto Rico, the U.S. Virgin Islands or Guam). Points are not earned on taxes, fees or body shop repair orders and expire without further notice upon Member Account deactivation. Visit [myChevroletrewards.com](https://myChevroletrewards.com) to view My GM Rewards Terms & Conditions.